

48 PO-HQ > 11A-V1JD616 (2011) > SCHNITTHÖHENVERSTELLUNG

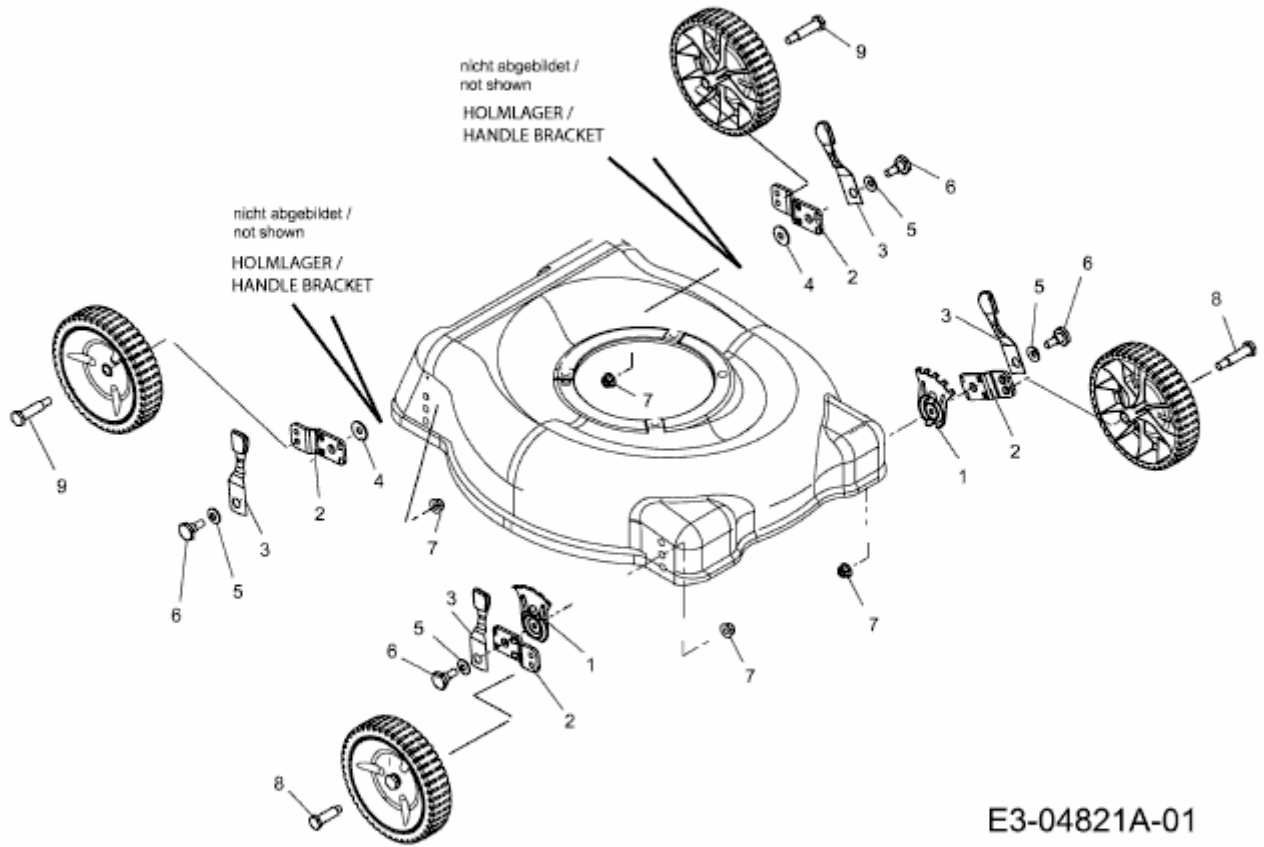

E3-04821A-01