

48 PO > 11A-V1JD600 (2011) > SCHNITTHÖHENVERSTELLUNG

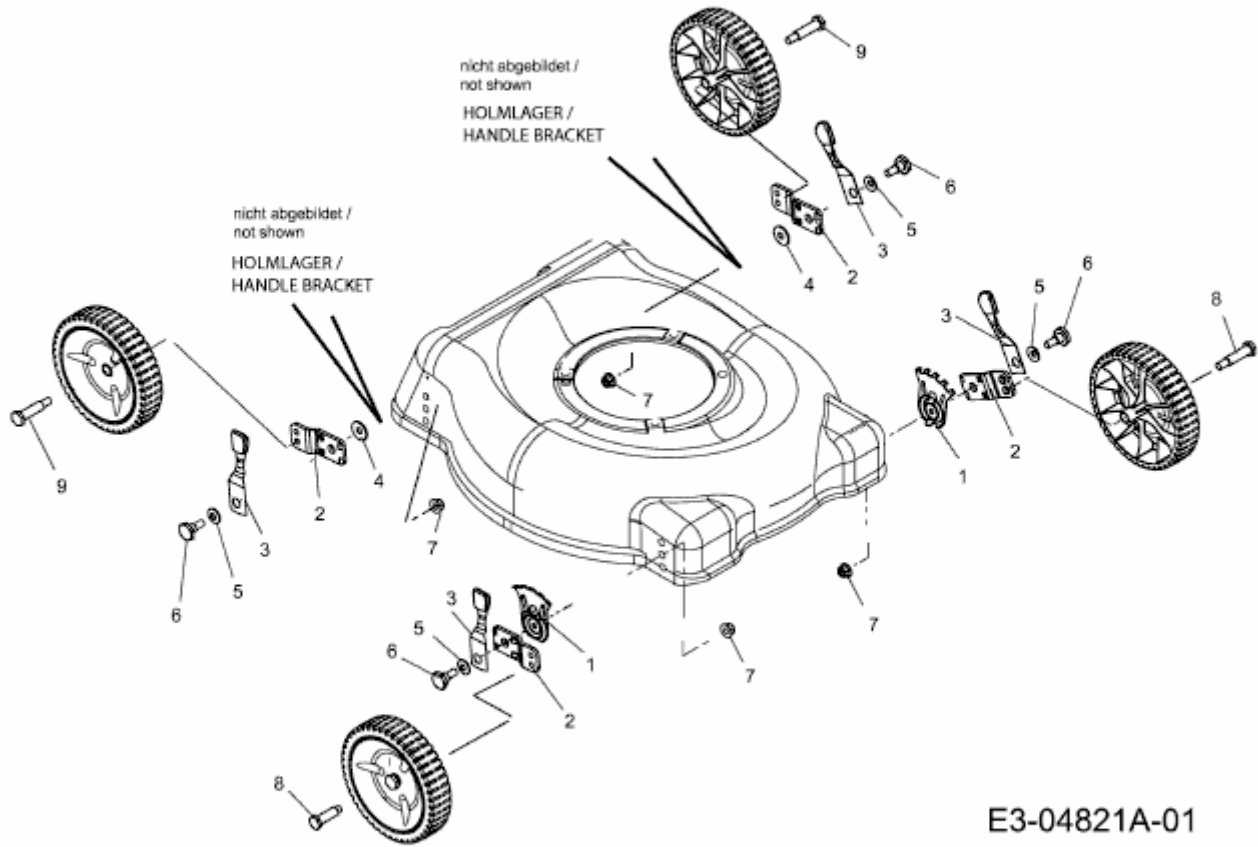

E3-04821A-01