

4048 HWM > 11A-V14M683 (2009) > SCHNITTHÖHENVERSTELLUNG

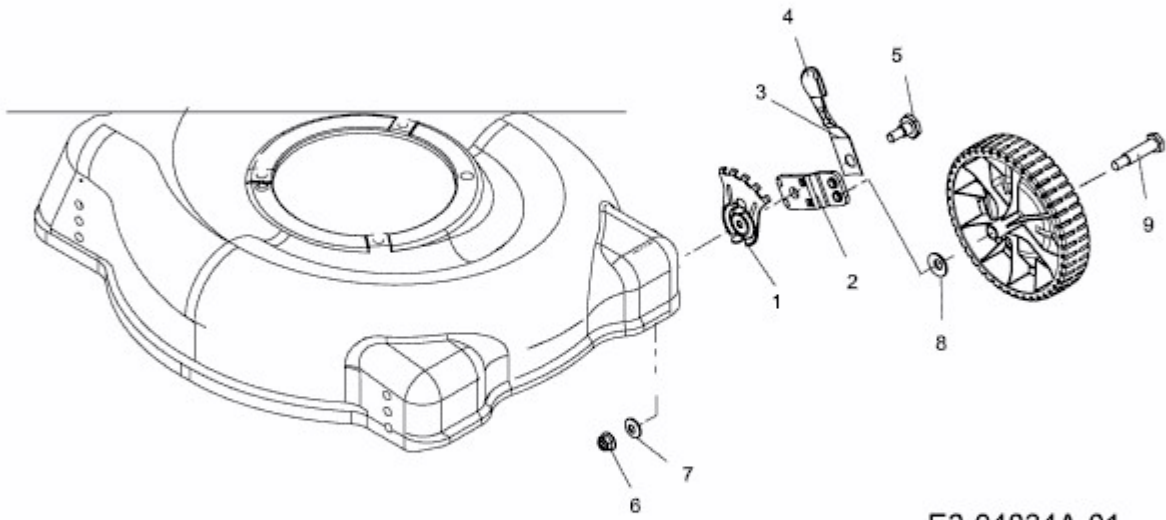

E3-04834A-01