

CC 46 PO > 11A-TQKC603 (2016) > ACHSEN, HÖHENVERSTELLUNG

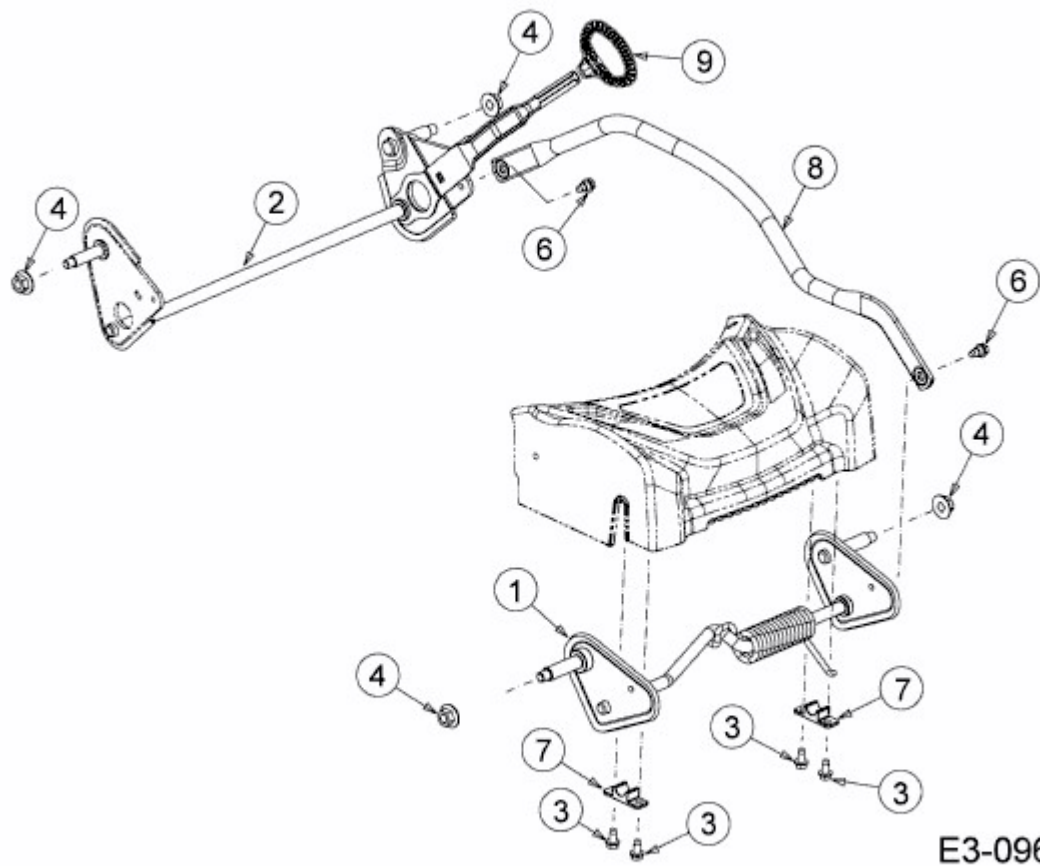

E3-09667A-01