

CC 46 PO > 11A-TQKC603 (2016) > MESSER, MESSERAUFNAHME

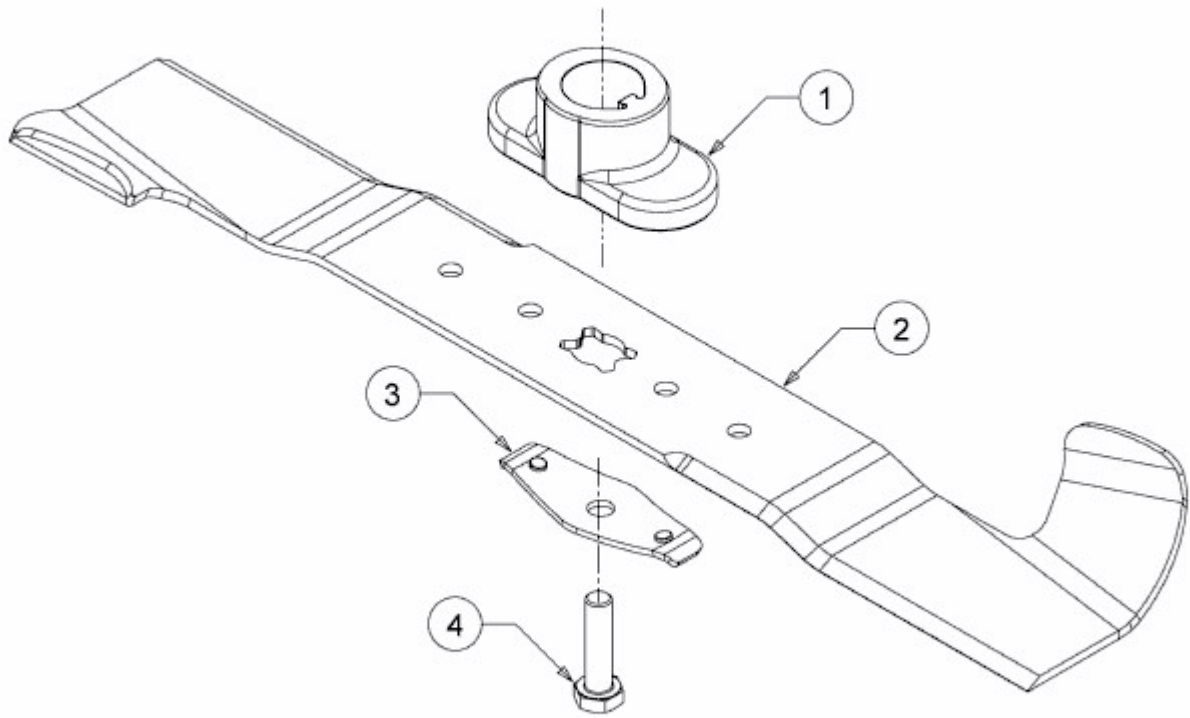

E3-03675A-01