

ab 01.09.2016  
from 01.09.2016  
à partir du 01.09.2016

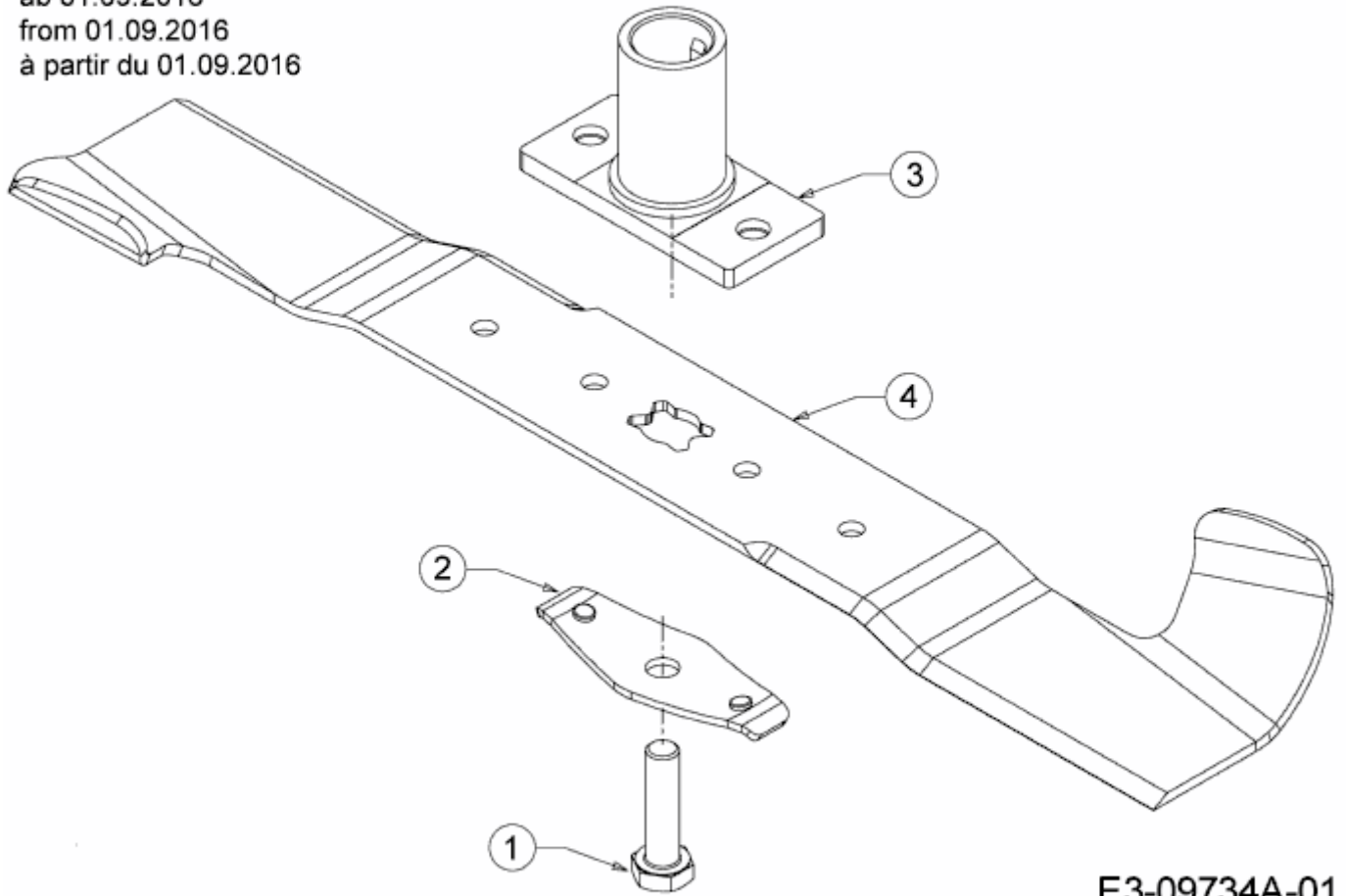

E3-09734A-01