

ab 26.11.2015
from 26.11.2015
à partir du 26.11.2015

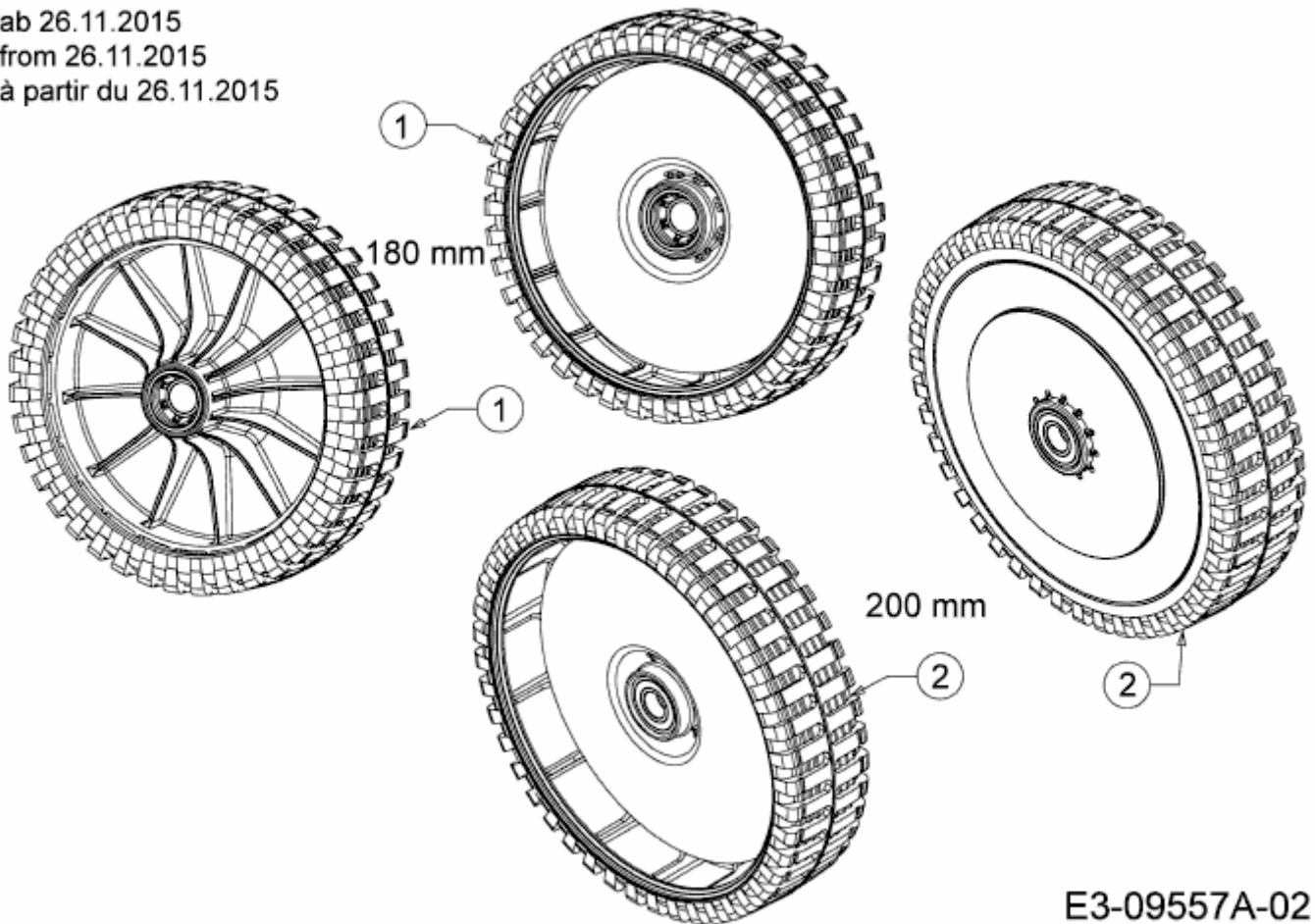

E3-09557A-02