

CC 42 PB > 11A-H65E603 (2013) > HOLM, BIS 19.03.2013

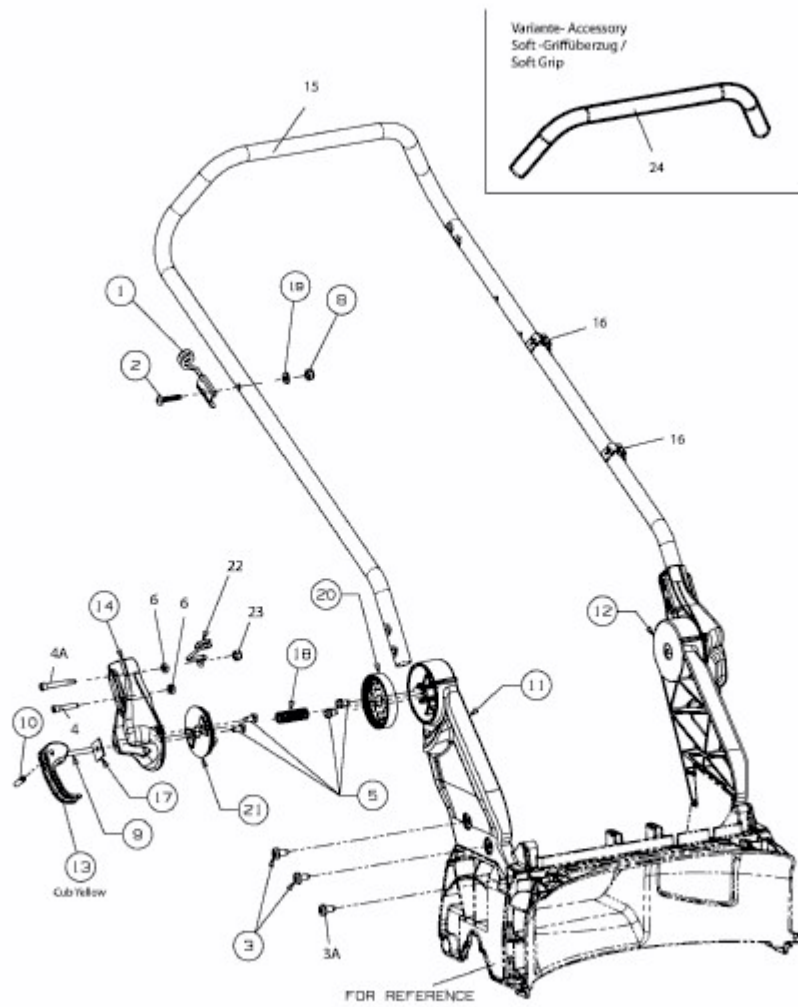

E3-07309A-01