

ab 31.10.2016
from 31.10.2016
à partir du 31.10.2016

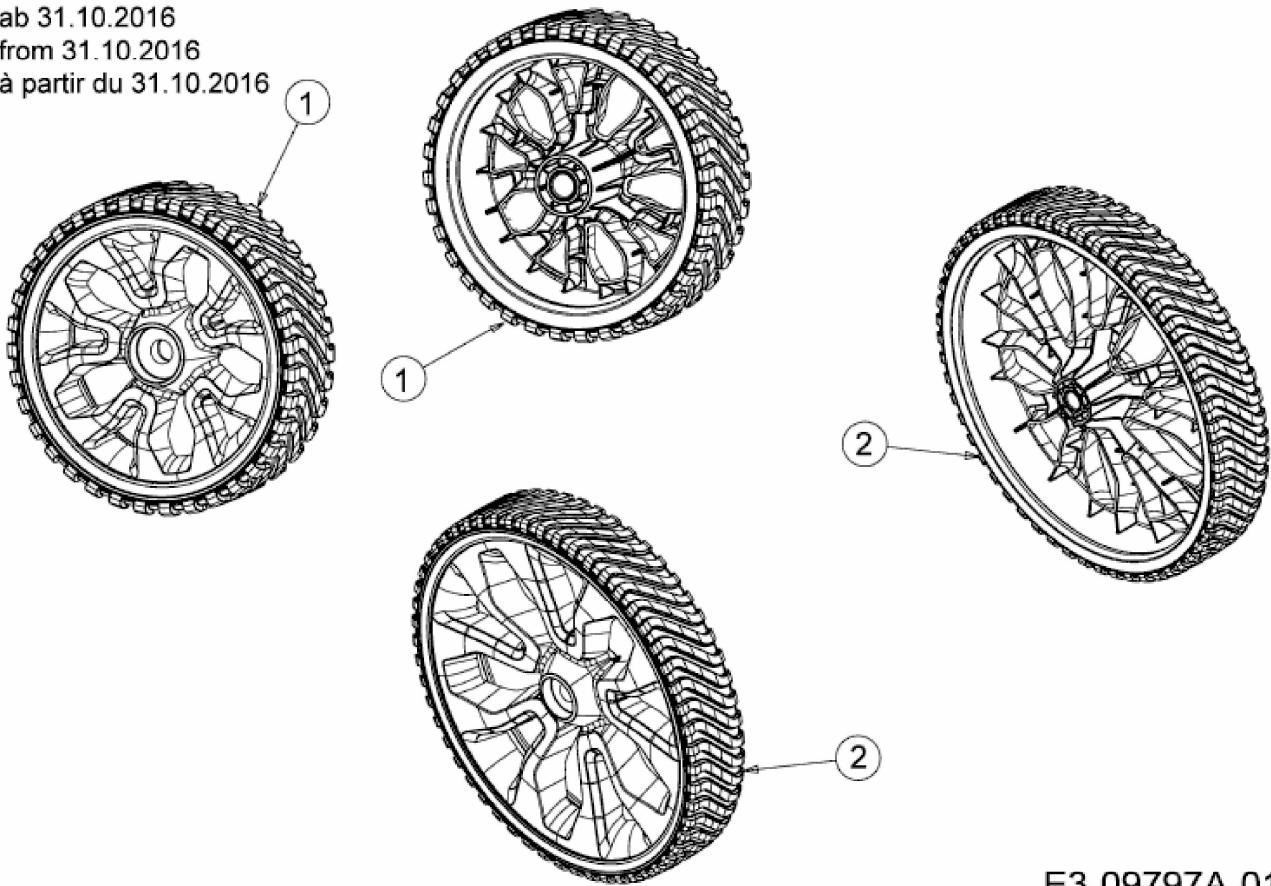

E3-09797A-01